

SCALE 1:4

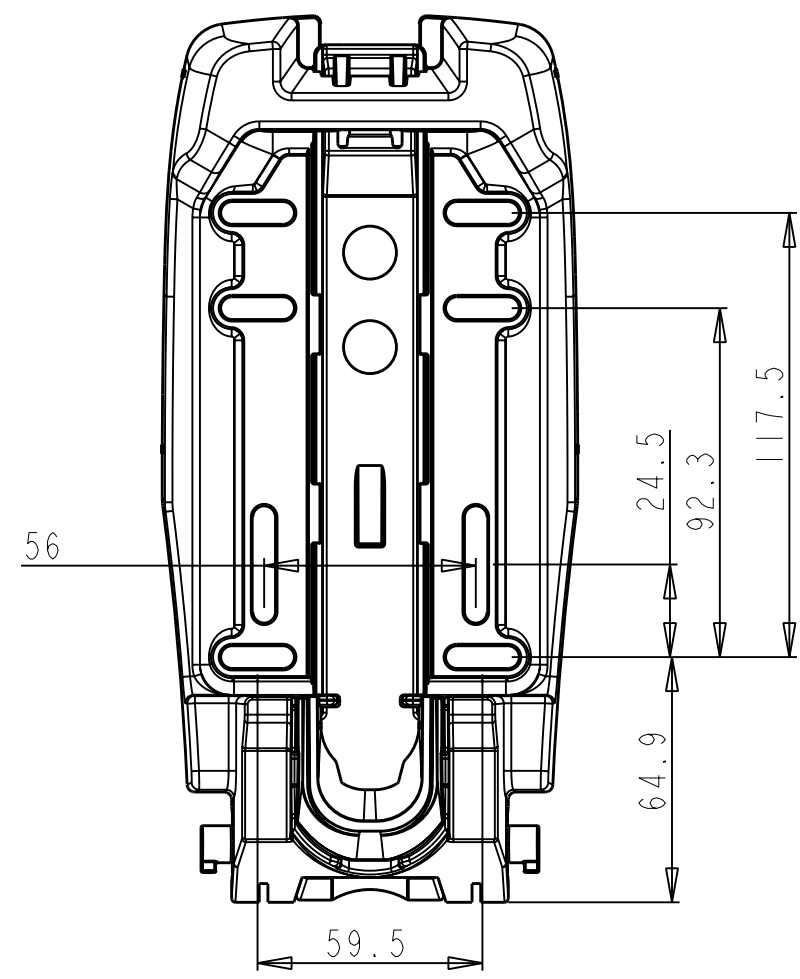

Drill pattern

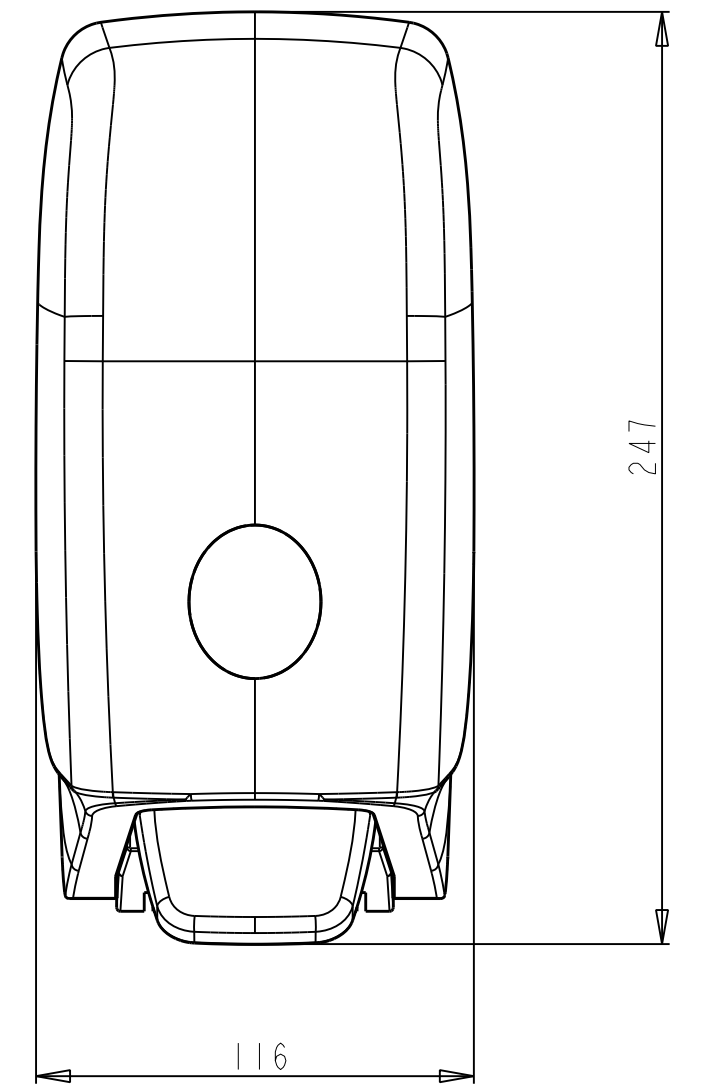
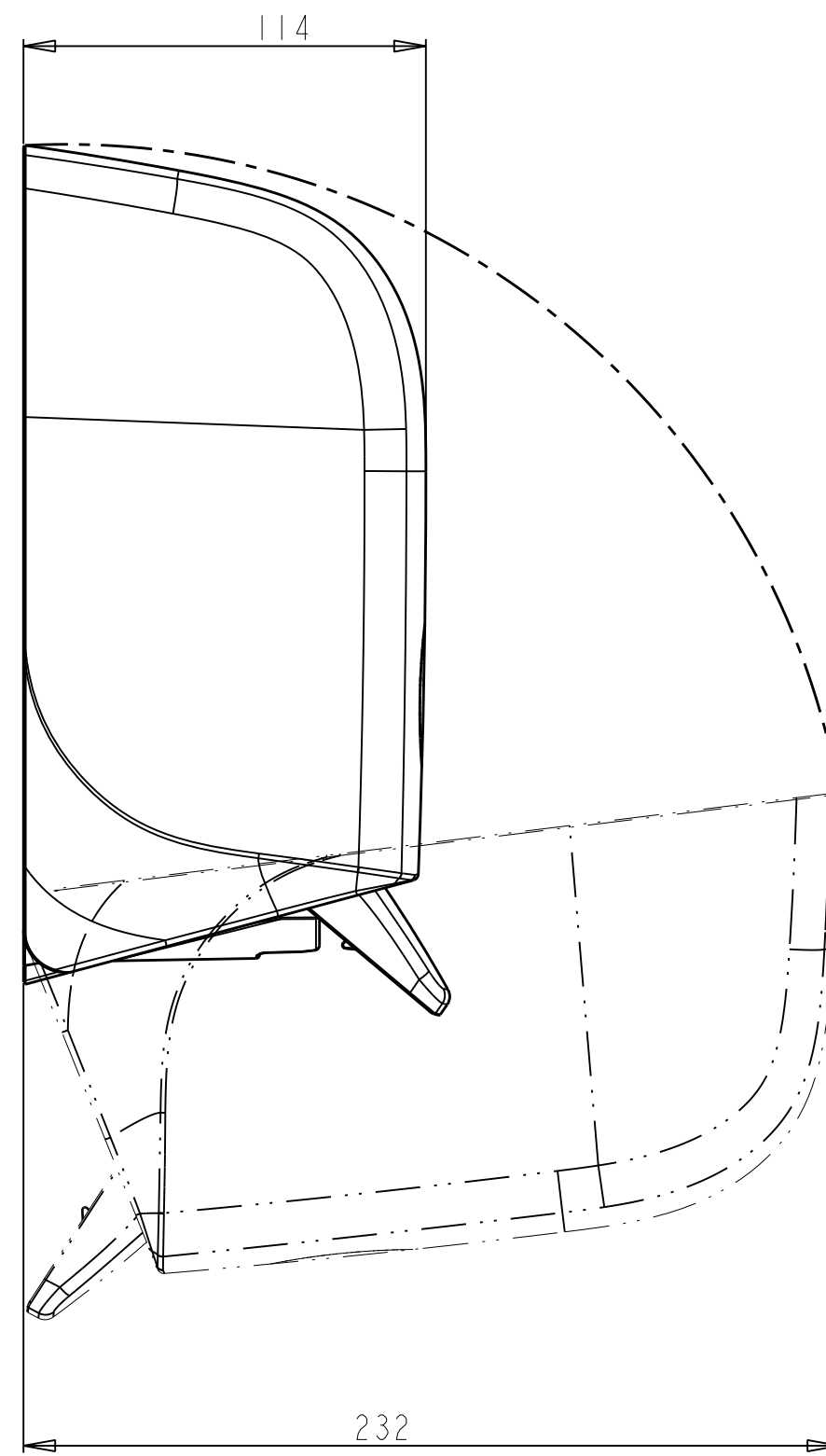

Dimensions in mm